

SR-DH Intelligent Wireless Dimming LED Solar Charge Controller

SR-DH100/SR-DH50/SR-DH20

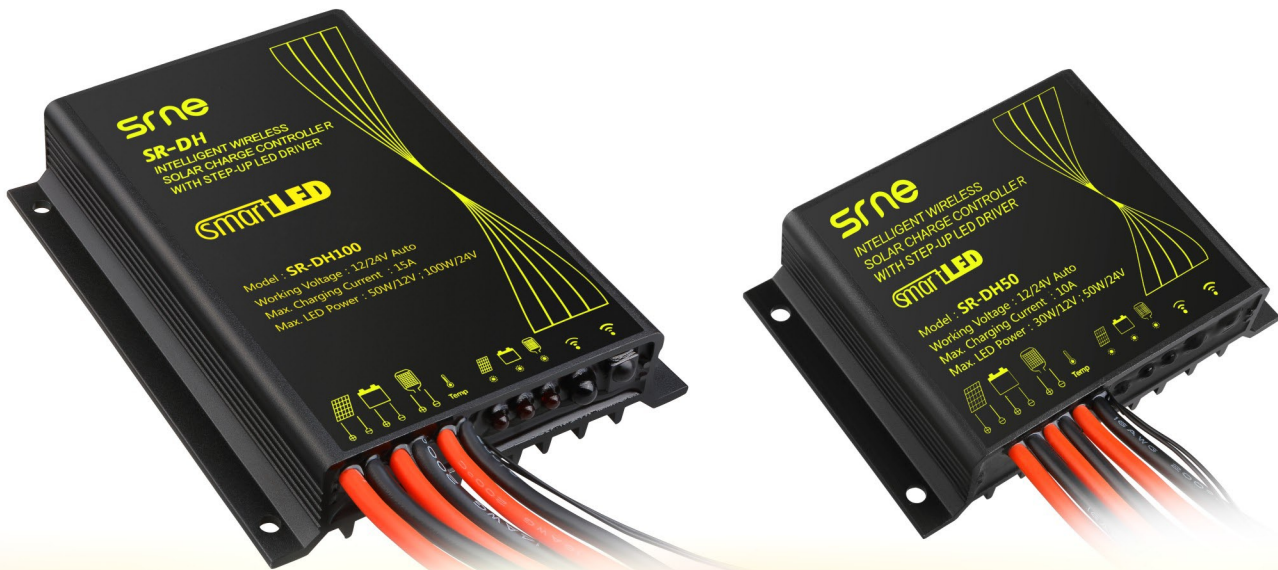

SR-DH100

SR-DH50
SR-DH20



Features

1. New design of wireless remote-control can modify the controller parameter and read the system message according to the handheld device.
2. Digital high precision constant-current control, the maximum efficiency can reach 96%.
3. The working current can be adjusted from 0.15A to 3.3A, the regulating precision is 30mA.
4. High dynamic performances of load insure current output stability even though the battery voltage and load sudden change.
5. 3 section time frame dimming function design, work time can be set range from 0h to 15 hours, power can be set range from 0% to 100%.
6. Intelligent power mode, the load power can be adjust automatically according to the battery power, can extend the maximum working time of the battery.
7. Record the system status, can record at a max 7days and monitor the whole system.
8. The true constant current but not limited the current, insure the current output stability thus decrease LED light failure, increase the LED service life.
9. Metal case, IP68 waterproof degree, can suitable use in all kinds of bad conditions.
10. With modified calculation of charging, the charging efficiency is improved, which lengthen the using time of solar energy.
11. Overheat preventing function, above a certain temperature will decrease the load or close the load.
12. Varies system protection function. Including the battery reverse connection, LED short circuit, open circuit protection and so on.

Product Picture

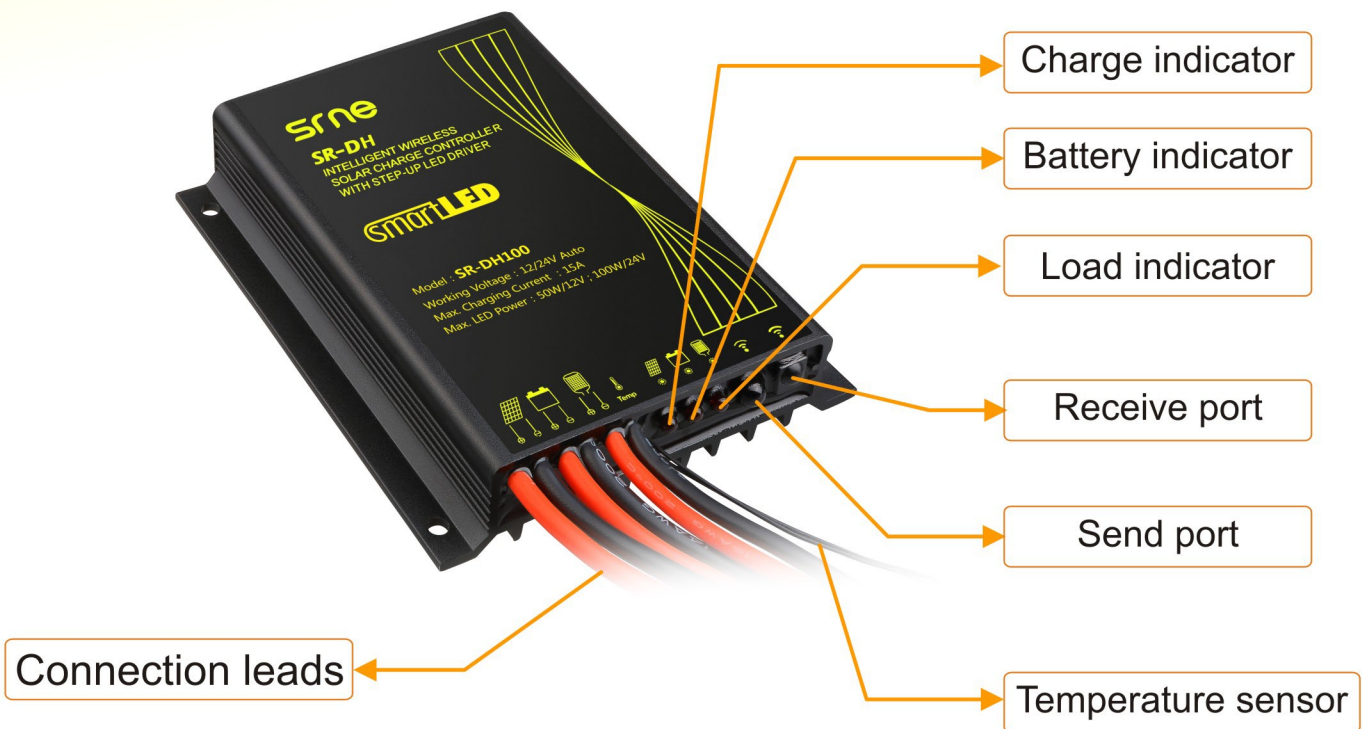

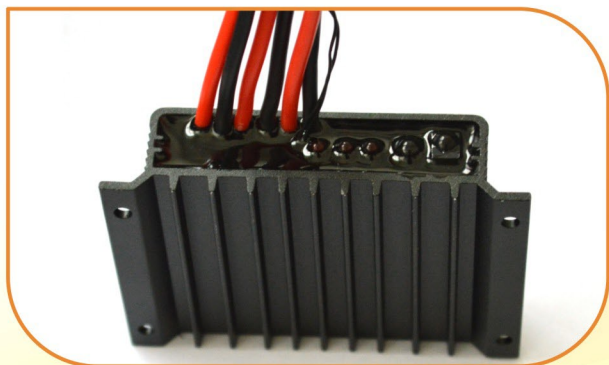
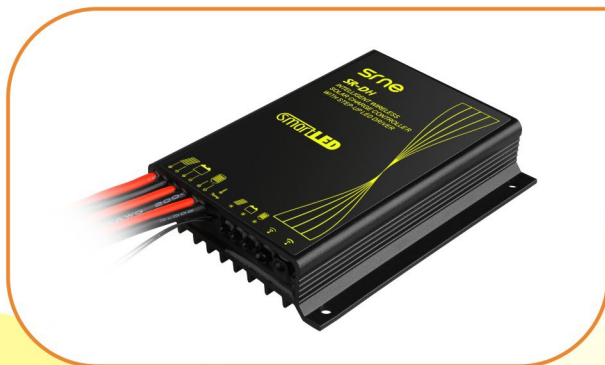

Product Detail

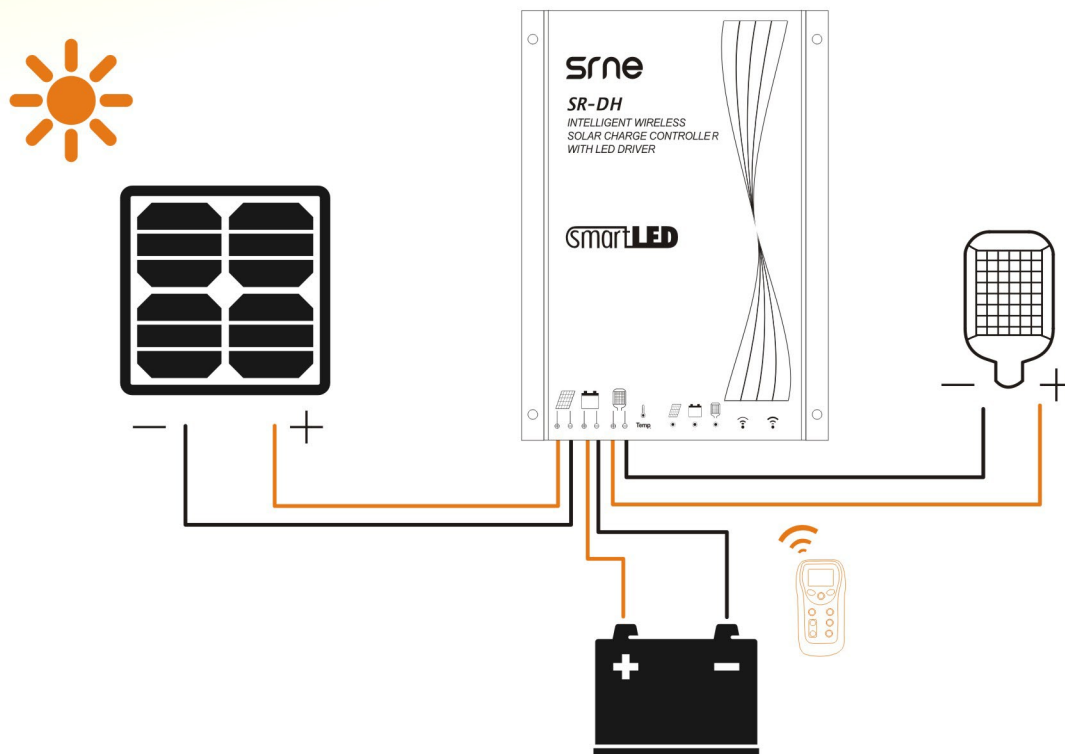

Wiring diagram is as below



Status Indication

LED light	Indications	Status	Functions
	Charging indication	Long-term On	The solar panel voltage is higher than light control voltage
		Long-term Off	The solar panel voltage is lower than light control voltage
		Slow twinkling	Be on charging
		Fast twinkling	Overpressure of system
	Battery indication	Long-term On	Storage battery works normally
		Long-term Off	Storage battery is not connected
		Fast twinkling	Storage battery is excessively discharged
	Load indication	Long-term On	Load is on
		Long-term Off	LED load is in short circuit or open circuit status.
		off	Load is off

Installation Dimension

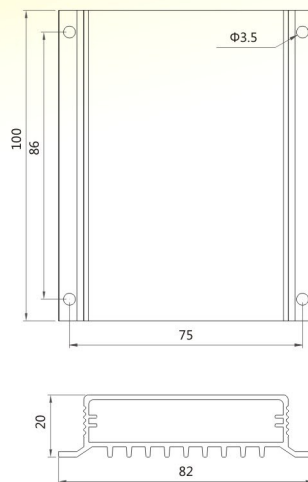

The size of SR-DH100 is as follows :
Boundary dimension : 82×100×20(mm)
Installation dimension : 86×75(mm)
Installation aperture : 3.5(mm)

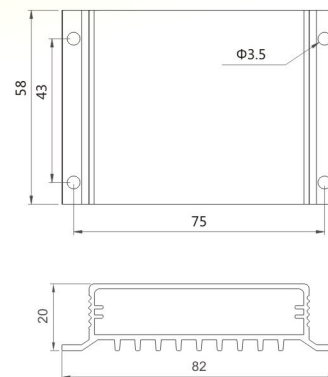

The size of SR-DH50 and SR-DH20 :
Boundary dimension : 82×58×20(mm)
Installation dimension : 43×75(mm)
Installation aperture : 3.5(mm)

The Parameters

Parameter Name	Parameter Value			Adjustable	Default value
Model	SR-DH100	SR-DH50	SR-DH20		
System voltage	12V/24V	12V/24V	12V		
Output power	50W/12V;100W/24V	30W/12V;50W/24V	20W		
Output current	0.15A~3.3A	0.15A~1.98A	0.15A~1.67A	✓	330mA
No-load loss	9mA/12V; 12mA / 24V		9mA /12V		
Charging current	15A	8A	5A		
Solar input voltage	<55V		<30V		
Efficiency of constant current	90% ~ 96%				
Overvoltage protection	16.0V ; ×2/24V				
Charging limits voltage	15.5V ; ×2/24V				
Equal charging voltage	15.2V ; ×2/24V (25°C)				
Equal charging interval	30days				
Ascending charging voltage	14.2V ~ 15.0V ; ×2/24V (25°C)			✓	14.4V
Float charging voltage	13.2V ~ 14.0V ; ×2/24V (25°C)			✓	13.8V
over-discharging recover voltage	12.0V ~ 13.0V ; ×2/24V			✓	12.6V
over-discharging voltage	9.8V ~ 11.8V ; ×2/24V			✓	11.0V
Temperature compensation	-4.0mv/°C/2V ;				
Current precision	±3% (Load current>300mA)				
Load output voltage	<60V				
over-temperature protection	ambient temperature:80°C (load drop power)				
overheat protection	internal temperature:120°C(Load off)				
light control voltage	5V ~ 11V			✓	5V
light control delay	5min ~ 50min			✓	5min
Working temperature	-35°C ~ +65°C ;				
Protection level	IP68				
Weight	280g	170g	160g		
Dimension (mm)	100*82*20(mm)	58*82*20(mm)			